

USER'S MANUAL

BM231
BM233
BM235



1) SAFETY

This manual contains information and warnings that must be followed for operating the meter safely and maintaining the meter in a safe operating condition. If the meter is used in a manner not specified by the manufacturer, the protection provided by the meter may be impaired.

Observe proper safety precautions when working with voltages above 30 Vrms, 42.4 Vpeak or 60 VDC. These voltage levels pose a potential shock hazard to the user. Do not expose this product to rain or moisture. The meter is intended only for indoor use.

Keep your hands/fingers behind the hand/finger barriers (of the meter and the test probe assembly, where applicable) that indicate the limits of safe access of the hand-held parts during measurements. Inspect lead wires, connectors, and probes for damaged insulation or exposed metal periodically. If any defects are found, replace them immediately. Only use the test probe assembly provided with the meter or a UL Listed test probe assembly to the same meter ratings or better.











Optional offer premium test probe assembly using silicone lead wire insulation, at agent's discretion, is equipped with white inner insulation layers as wear indicators. Replace them immediately if any of the white layers has become visible.

Disconnect the test leads from the test points before changing functions.

The meter meets IEC/EN/BSEN/CSA_C22.2_No./UL standards of 61010-1 Ed. 3.1 and 61010-2-033 Ed. 2.0 to Measurement Categories CAT III 600V and CAT IV 300V AC & DC

The accompanied test probe assembly meets IEC/EN/BSEN/CSA_C22.2_No./UL standards of 61010-031 Ed. 2.0 to the same meter ratings or better. The 61010-031 requires exposed conductive test probe tips to be $\leq 4\text{mm}$ for CAT III & CAT IV ratings. Refer to the category markings on your probe assemblies as well as on the add-on accessories (like detachable Caps or Alligator Clips), if any, for applicable rating changes.

INTERNATIONAL SYMBOLS

	Marking of Electrical and Electronic Equipment (EEE). Do not dispose of this product as unsorted municipal waste. Contact a qualified recycler
	Refer to the explanation in this Manual
	Possibility of electric shock
	Earth (Ground)
	Meter protected throughout by Double Insulation or Reinforced insulation
	Fuse
	Direct Current (DC)
	Alternating Current (AC)
	Three-phase Alternating Current
	Application around and removal from hazardous live conductors is permitted

Brief Information about Measurement Categories

Measurement Category IV is applicable to test and measuring circuits connected at the source of the building's low-voltage MAINS installation. Examples are measurements on devices installed before the main fuse or circuit breaker in the building installation.

Measurement Category III is applicable to test and measuring circuits connected to the distribution part of the building's low-voltage MAINS installation. Examples are measurements on distribution boards (including secondary meters), circuit-breakers, wiring, including cables, bus-bars, junction boxes, switches, socket-outlets in the fixed installation, and equipment for industrial use and some other equipment such as stationary motors with permanent connection to the fixed installation.

Measurement Category II is applicable to test and measuring circuits connected directly to utilization points (socket outlets and similar points) of the low-voltage MAINS installation. Examples are measurements on MAINS CIRCUITS of household appliances, portable tools and similar equipment.

2) EUROPEAN DIRECTIVES AND UK STATUTORY REQUIREMENTS

The instruments conform to EUROPEAN (CE) Low-Voltage Directive 2014/35/EU, Electromagnetic Compatibility Directive 2014/30/EU, and RoHS 2 Directive 2011/65/EU plus amendment Directive (EU) 2015/863. The instruments also conform to the UK (UKCA) Electrical Equipment (Safety) Regulations 2016, Electromagnetic Compatibility Regulations 2016, and The Restriction of the Use of Certain Hazardous Substances in Electrical and Electronic Equipment Regulations 2012.

3) PRODUCT DESCRIPTION

Note: Top of the line model is used as representative for illustration purposes. Please refer to your respective model for function availability.

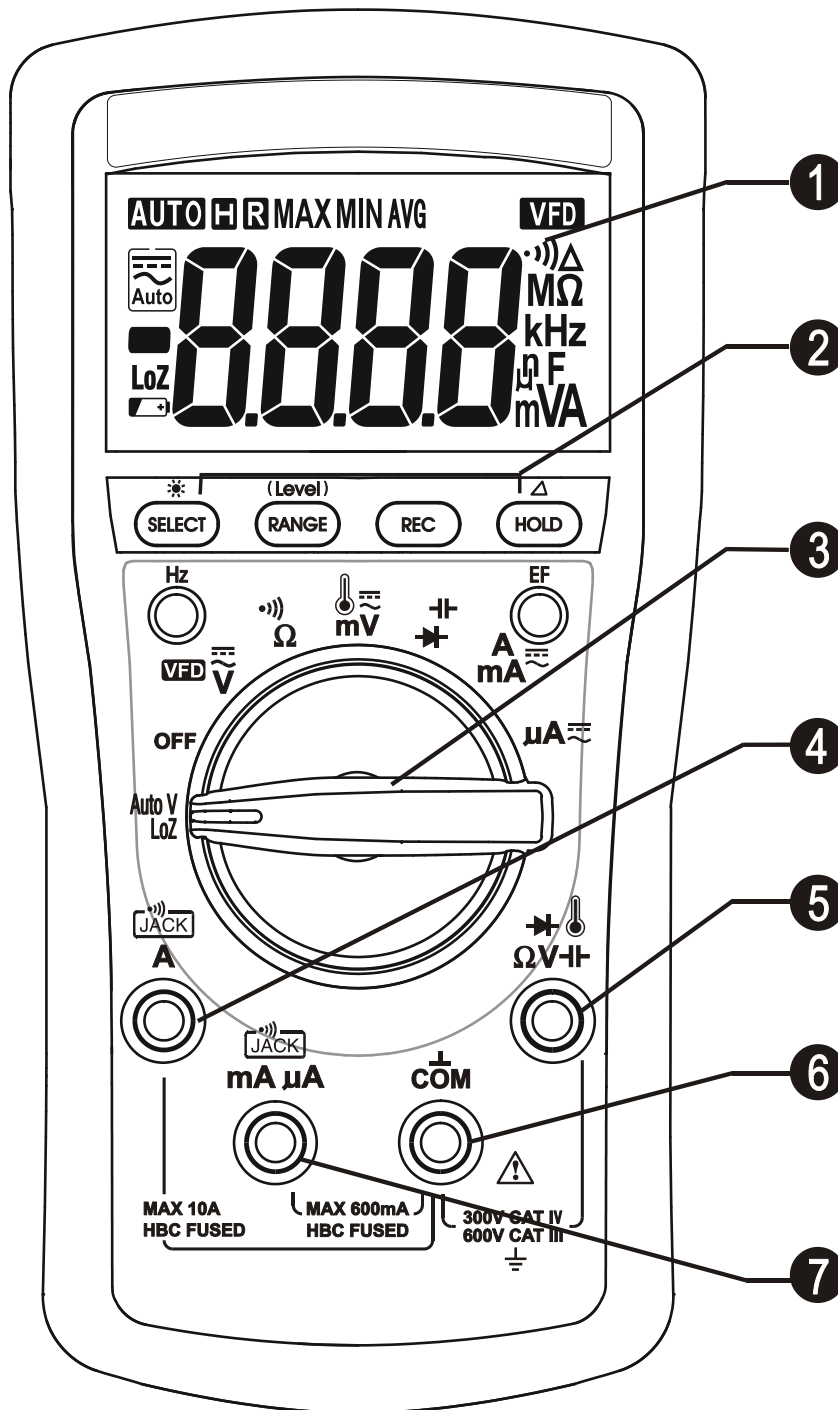

1) 3-5/6 digits 6000 counts LCD display

2) Push-buttons for special functions & features

3) Selector to turn the Power On or Off and Select a function

4) Input Jack for 10A (20A for 30sec) current function

5) Input Jack for all functions EXCEPT μA , mA & A current functions

6) Common (Ground reference) Input Jack for all functions

7) Input Jack for μA and mA current function

True RMS

RMS (Root-Mean-Square) is a term used to describe the effective or equivalent DC value of an AC signal. True RMS is the term which identifies a DMM that responds accurately to the effective RMS value regardless of the waveforms such as: square, sawtooth, triangle, pulse trains, spikes, as well as distorted waveforms with the presence of harmonics. Harmonics may cause :

- 1)Overheated transformers, generators and motors to burn out faster than normal
- 2)Circuit breakers to trip prematurely
- 3)Fuses to blow
- 4)Neutrals to overheat due to the triplen harmonics present on the neutral
- 5)Bus bars and electrical panels to vibrate

Crest Factor

Crest Factor is the ratio of the Crest (instantaneous peak) value to the True RMS value, and is commonly used to define the dynamic range of a True RMS DMM. A pure sinusoidal waveform has a Crest Factor of 1.414. A badly distorted sinusoidal waveform normally has a much higher Crest Factor.

4) OPERATION

NOTE

Before and after hazardous voltage measurements, test the voltage function on a known source such as line voltage to determine proper meter functioning.

AutoV (LoZ) (Model 235 only)

AutoV automatically selects measurement function of DCV or ACV based, on their input levels via the test leads. The input also provides a low ramp-up impedance (LoZ) to drain ghost voltages*.

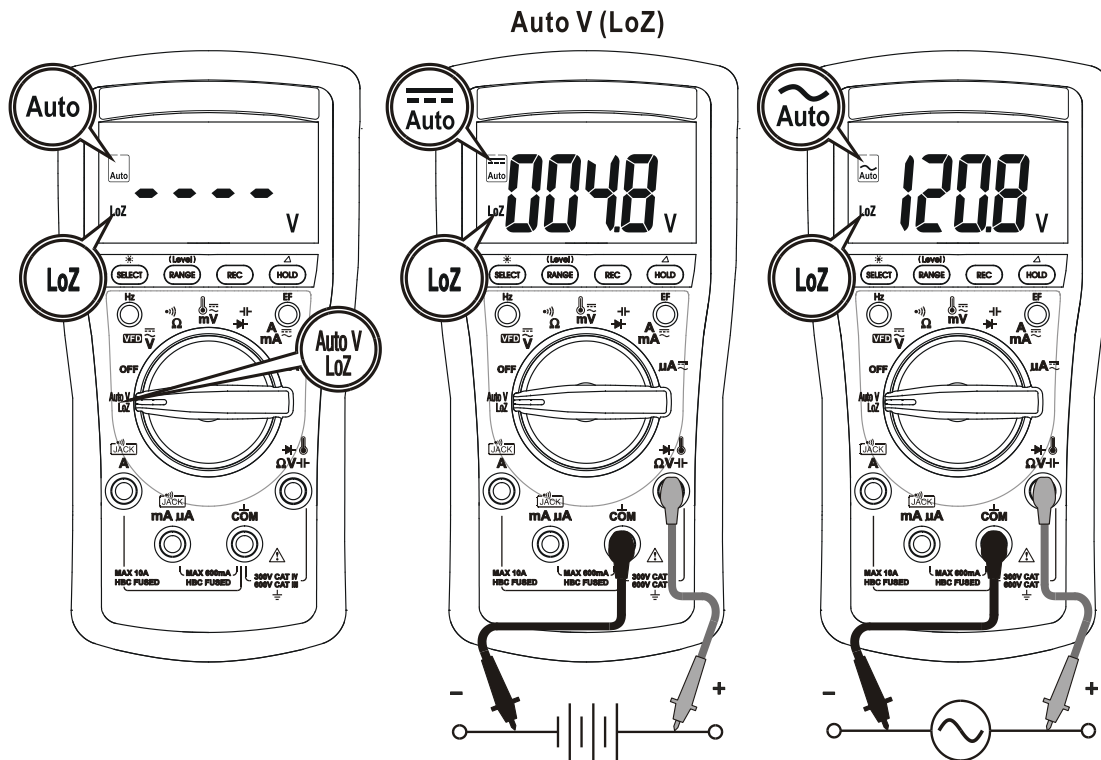

- With no input, the meter displays “ - - - ” when it is ready.
- When a signal above the voltage threshold of 1V DC or AC up to the rated 600V is present, the meter displays the voltage value in appropriate DC or AC, whichever larger in peak magnitude.

Note:

***Ghost-voltage Buster:** Ghost-voltages are unwanted stray signals coupled from adjacent hard signals, which confuse common multimeter voltage measurements. The **AutoV** mode provides low (ramp-up) input impedance (approx. 2.1k Ω at low voltage) to drain ghost voltages leaving mainly hard signal values on meter readings. It is an invaluable feature for precise indication of hard signals, such as distinguishing between hot and open wires (to ground) in electrical installation applications.

*Only **HOLD**, **EF** & **Backlight** push-button features are available in AutoV mode.

NOTE:

AutoV mode input impedance increases abruptly from initial $2.1\text{k}\Omega$ to a few hundred $\text{k}\Omega$'s on high voltage hard signals. "**LoZ**" displays on the LCD to remind the users of being in such low impedance mode. Peak initial load current, while probing 600VAC for example, can be up to 404mA ($600\text{V} \times 1.414 / 2.1\text{k}\Omega$), decreasing abruptly to approx. 3.5mA ($600\text{V} \times 1.414 / 240\text{k}\Omega$) within a fraction of a second. Do not use **AutoV** mode on circuits that could be damaged by such low input impedance. Instead, use rotary selector $\tilde{\sim}$ or $\bar{\sim}$ high input impedance voltage modes to minimize loading for such circuits.

ACV, DCV & VFD-ACV

Press the **SELECT** button momentarily to select the subject functions in sequence. Last selection will be saved as power up default for repeat measurement convenience.

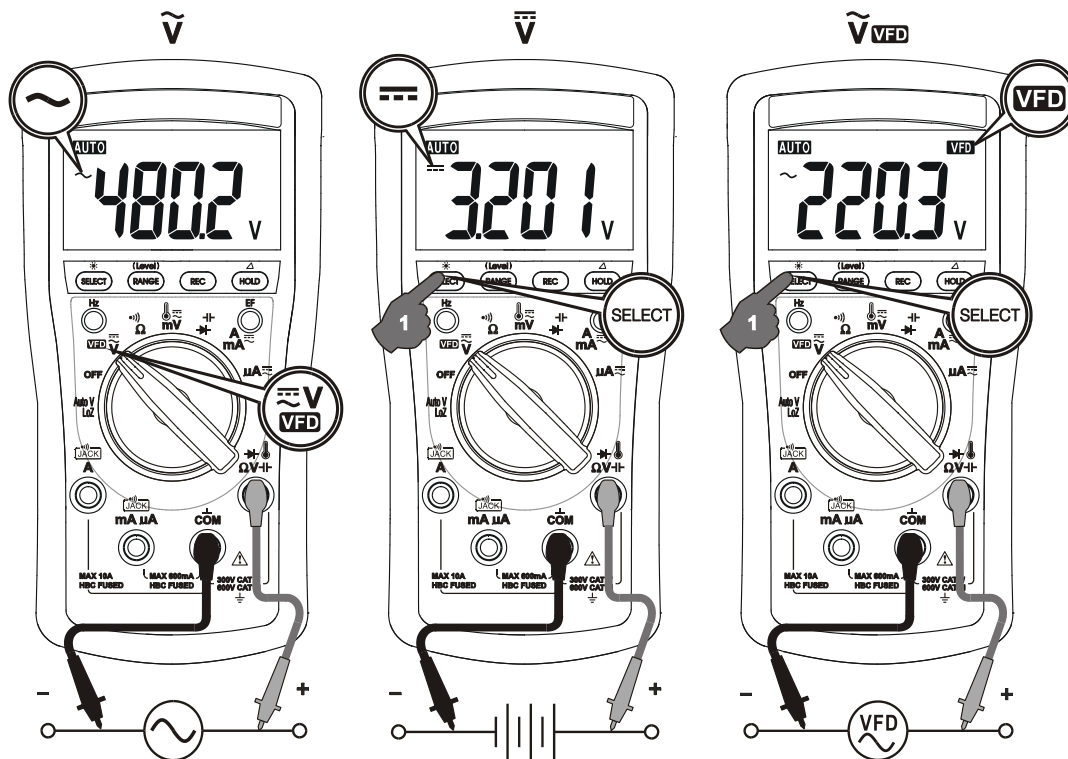
**Note:**

VFD-ACV and the associated **Hz** are equipped with digital low-pass filter (DSP), and are capable of handling **VFD** (Variable Frequency Drives) signals for fundamental V & Hz readings. It also improves ACV and Hz reading stability when being used in most noisy electrical environments.

Line Frequency (Models 233 & 235 only)

Press the **Hz** push-button momentarily to toggle Hz function. It is only available to Voltage and Current related ranges.

*Input sensitivity varies automatically with the function range selected while activating the Hz function. 6V function range has the highest and the 1000V function range has the lowest. When activated under DCV, ACV or VFD-ACV voltage function, the trigger voltage range will be displayed right before starting the Hz readings. Press momentarily the **RANGE** button can manually select another trigger voltage range (not available to current ranges). It is recommended to first measure the signal voltage (or current) level and activate Hz function in that range to get the most appropriate trigger level. If the Hz reading becomes unstable, select lower sensitivity to avoid electrical noise. If the reading shows zero, select higher sensitivity.*

Hz of VFD-ACV

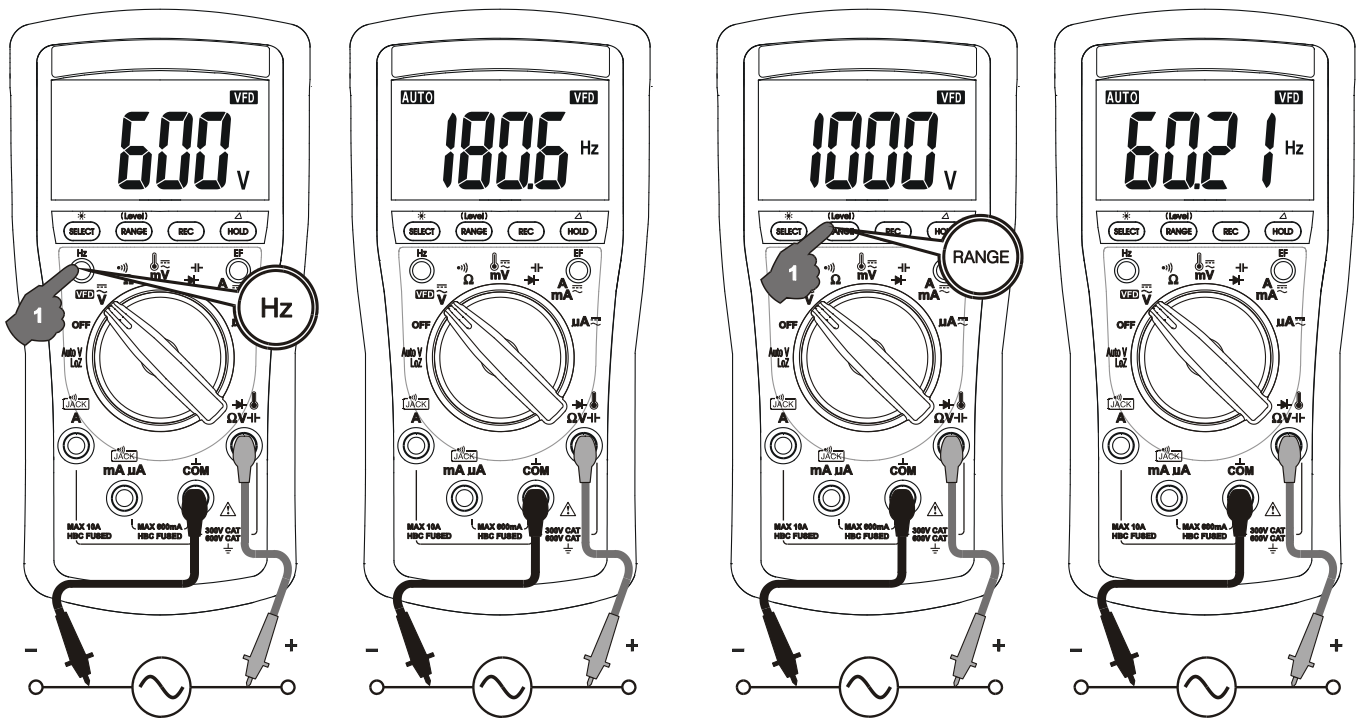

Resistance & BeepLit™ Continuity

Press the **SELECT** button momentarily to toggle the functions. Last selection will be saved as power up default for repeat measurement convenience.

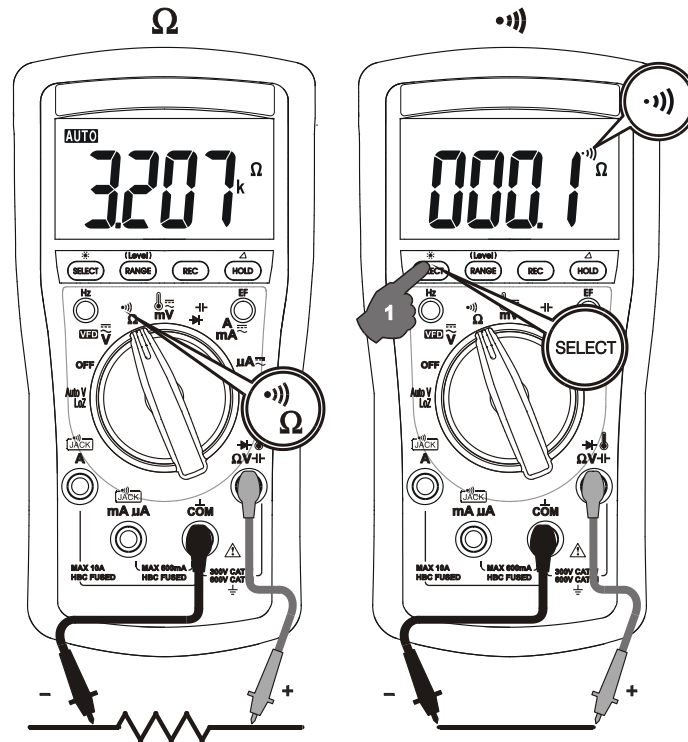

BeepLit™ Continuity function is having improved convenience for checking wiring connections and operation of switches. A continuous beep tone together with flashing display backlight indicate a complete wire. Such audible and visible indications improve continuity readabilities in noisy working environments.

NOTE

Using resistance and continuity function in a live circuit will produce false results and may damage the instrument. In many cases the suspected component must be disconnected from the circuit to obtain an accurate reading

Capacitance (Models 235 & 233 only); Diode

Press the **SELECT** button momentarily to toggle the functions. Last selection will be saved as power up default for repeat measurement convenience.

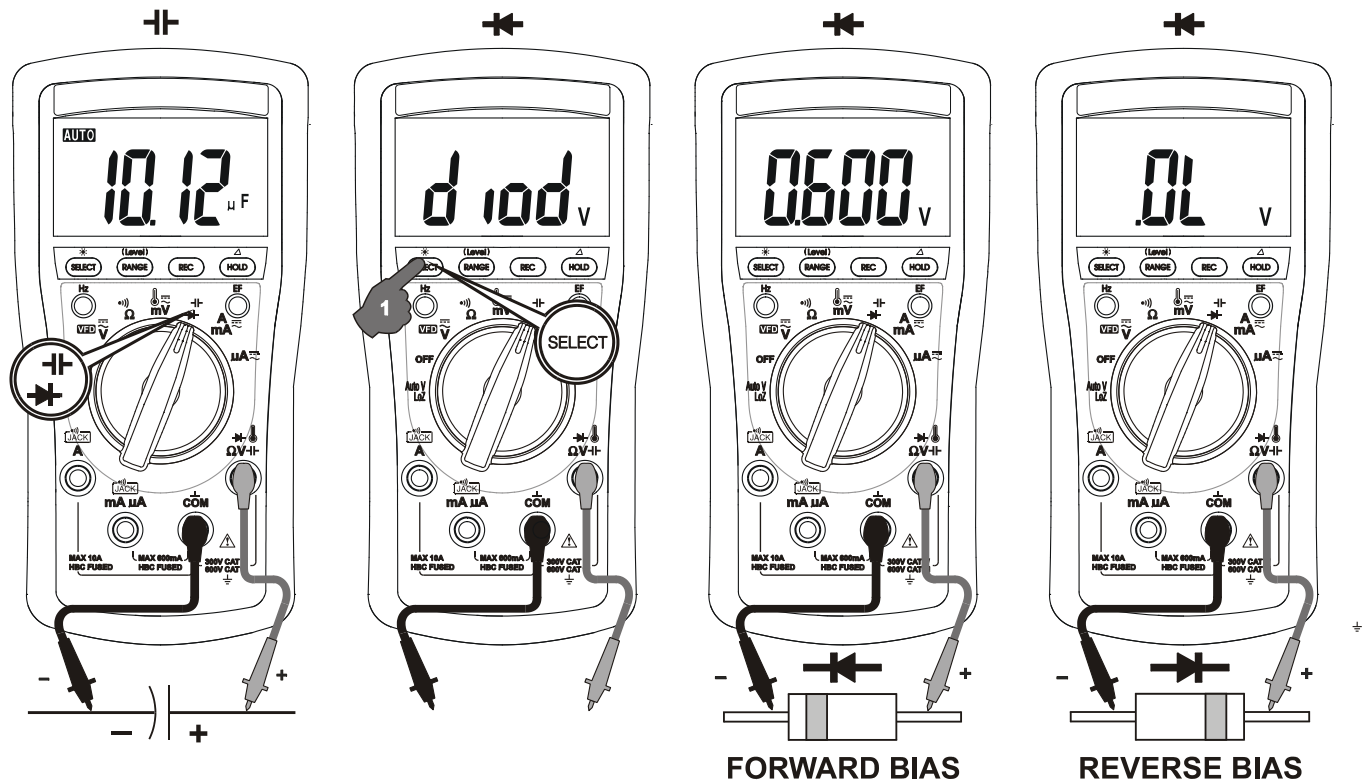

In **Diode** function, the normal forward voltage drop (forward biased) for a good silicon diode is between 0.400V to 0.900V. A reading higher than that indicates a leaky diode (defective). A zero reading indicates a shorted diode (defective). An OL indicates an open diode (defective). Reverse the test leads connections (reverse biased) across the diode. The digital display shows OL if the diode is good. Any other readings indicate the diode is resistive or shorted (defective).

NOTE

Discharge capacitors before making any measurement. Large value capacitors should be discharged through an appropriate resistance load.

ACmV, DCmV; Temperature °C & °F (Model 235 only)

Press the **SELECT** button momentarily to select the subject functions in sequence.

Last selection will be saved as power up default for repeat measurement convenience.

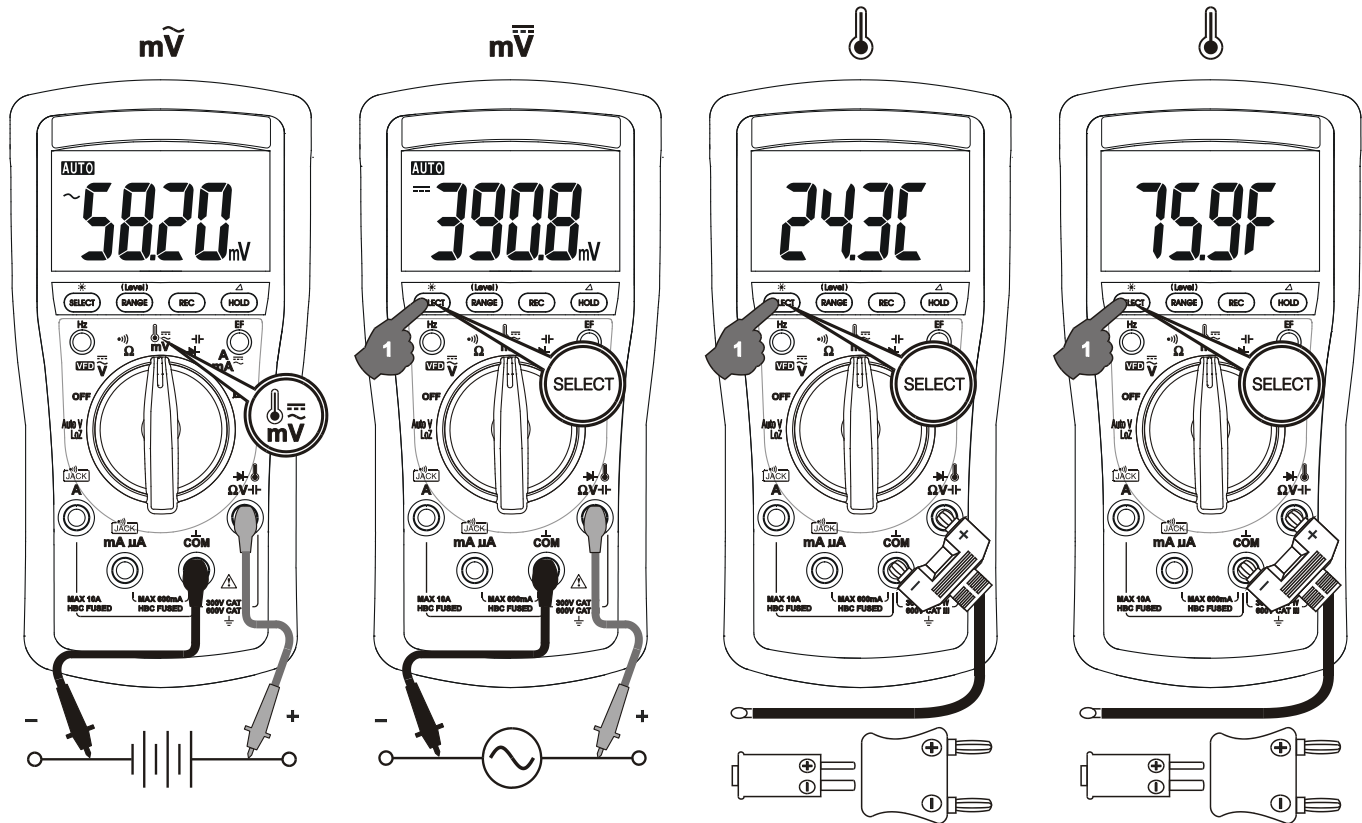

Note: Be sure to insert the banana plug type-K temperature bead probe Bkp60 with correct **+** **-** polarities. You can also use a plug adapter Bkb32 (Optional purchase) with banana pins to type-K socket to adapt other standard type-K mini plug temperature probes.

μA , mA & A Current

Press **SELECT** button momentarily to toggle between DC and AC. Last selection will be saved as power up default for repeat measurement convenience.

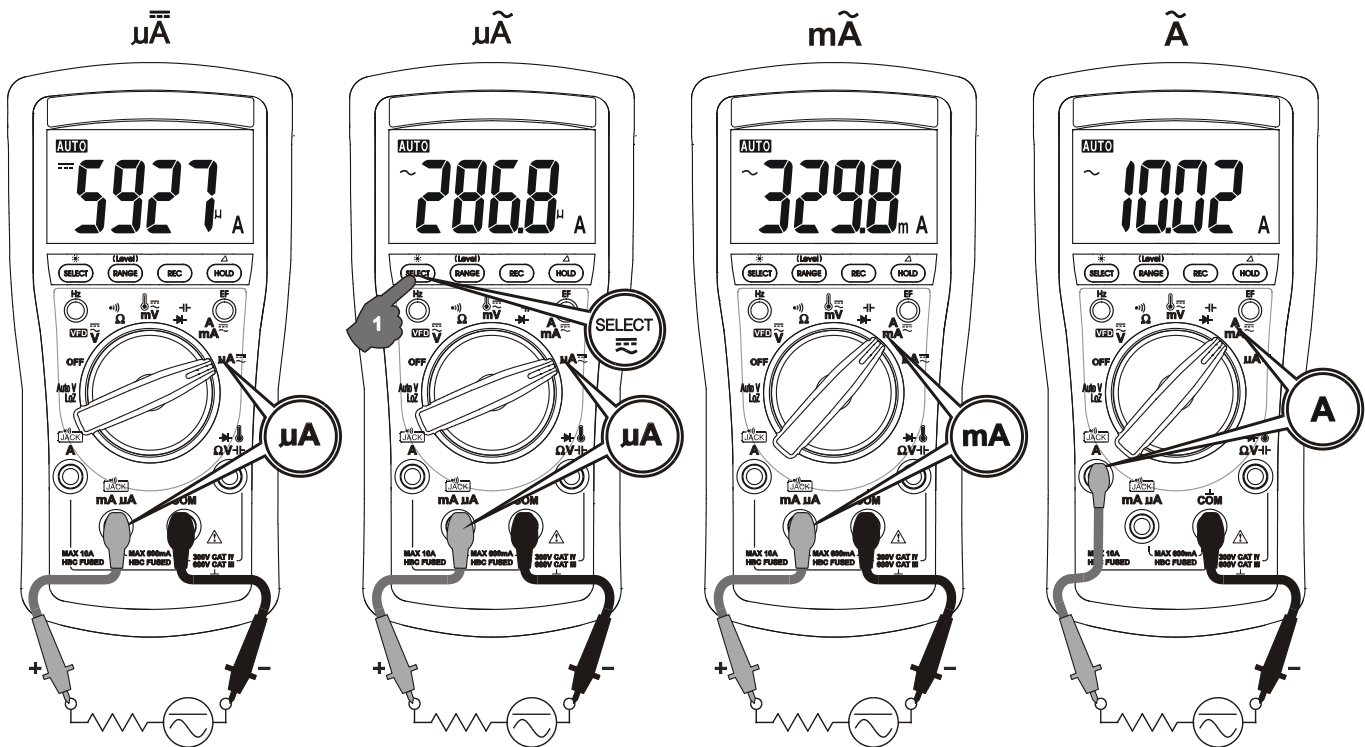

Application notes for flame sensors:

DC μA function is useful for HVAC/R flame sensor applications. The 0.1 μA resolution can identify the minute current changes in flame detector applications. Flame signal current check should indicate steady flame signal of at least 2 μA for a rectification type, or 1.5 μA for an ultraviolet type (8 μA for self checking systems). If a flame signal current with inadequate strength or fluctuation beyond 10%, check the following to avoid the risk of unwanted flame relay dropout :

For gas or oil flames (Minipeeper):

- Low supply voltage
- Detector location
- Defective detector wiring
- Dirty viewing windows
- Faulty Minipeeper

For oil flames (Photocell):

- Detector location & wiring
- Smoky flame or poorly adjusted air shutter

- Faulty Photocell
- Temperature over 165 °F (74 °C) at photocell

For gas flames (Flame Rod):

- Ignition interference (A flame signal current difference with the ignition both on and off greater than 0.5 μ A indicates the presence of ignition interference)
- Insufficient ground (must be at least 4 times the detector area)
- Flame lifting off burner head (ground), or not continuously in contact with the flame rod
- Temperature in excess of 600 °F (316 °C) at the flame electrode insulator causing short to ground.

Electric Field EF-Detection

Press the **EF** button momentarily to toggle EF-Detection feature. The meter displays “**EF-H**” when it is ready. If it is too sensitive for your applications, press (**Level**) button momentarily toggles to lower sensitivity “**EF-L**”. The detected Electric Field strength is indicated as a series of bar-graph segments on the display plus variable beep tones.

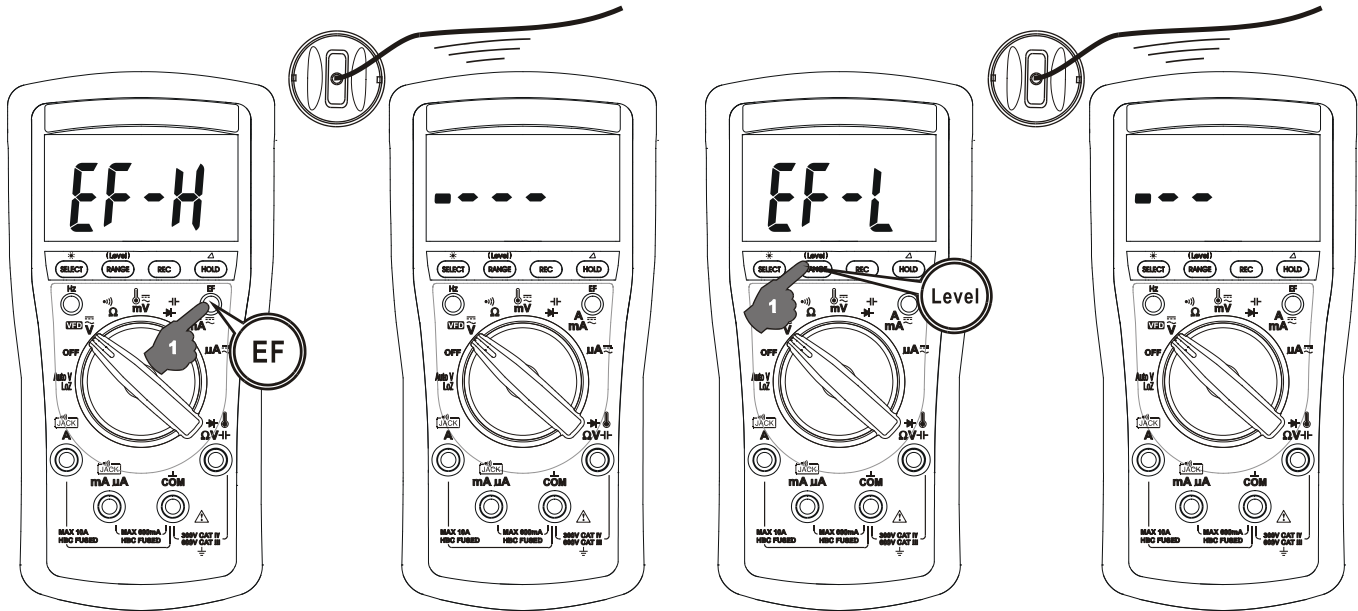

● **Non-Contact EF-Detection:** An antenna is located along the top-left end of the meter, which detects electric field surrounding energized live conductors. It is ideal for tracing live wiring connections, locating wiring breakages and to distinguish between live and earth connections.

● **Probe-Contact EF-Detection:** For more precise indication of live wires, such as distinguishing between Live and Ground connections, use direct contact testing with one single test-probe via the input terminal COM or V. The COM terminal (Black) has the best sensitivity.

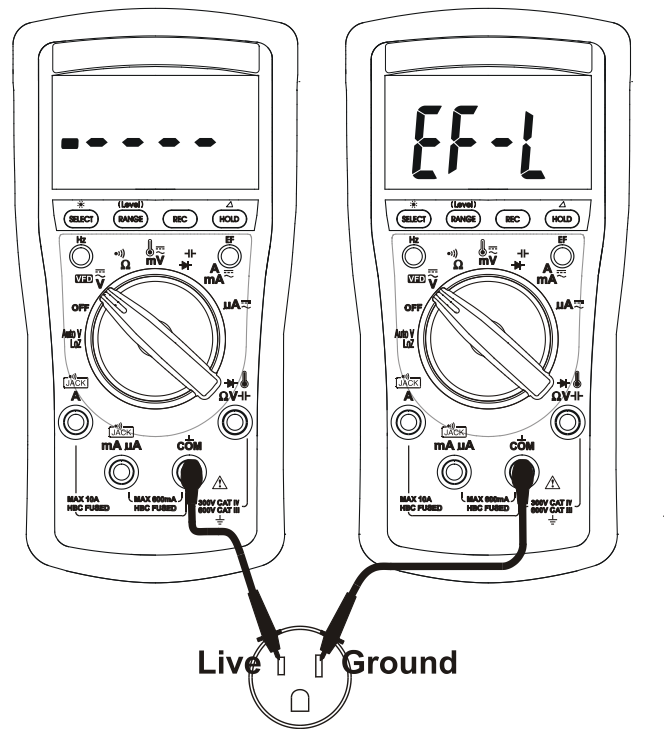

MAX/MIN/AVG Record mode

Press **REC** button momentarily to activate MAX/MIN/AVG recording mode. The LCD “MAX MIN AVG” turn on. The meter beeps when new MAX (maximum) or MIN (minimum) reading is updated. Press the button momentarily to read the MAX, MIN, AVG readings in sequence. Press the button for 1 second or more to exit MAX/MIN/AVG recording mode. Auto-ranging remains, and Auto-Power-Off is disabled automatically in this mode.

Backlight LCD display

Press the **SELECT** button for 1 second or more to toggle the LCD backlight. The backlight will also be turned off automatically after 10 minutes to extend battery life.

Hold

The hold feature freezes the display for later view. Press the **HOLD** button momentarily to toggle the hold feature.

Relative Zero (Δ) mode

Relative Zero allows the user to offset the meter consecutive measurements with the displaying reading as the reference value. Practically all displaying readings can be set as relative reference value including MAX/MIN/AVG feature readings. Press the Δ button for one second or more to toggle Relative Zero mode.

Manual or Auto-ranging

For most auto-ranging functions (LCD **AUTO** turns on by default), press the **RANGE** button momentarily to select manual-ranging override. The meter will remain in the range it was in, the LCD **AUTO** turns off. Press the button momentarily again to select the next range. Press and hold the button for 1 second or more to resume auto-ranging.

Note: Manual-ranging feature is not available to Auto-V, Capacitance & Hz functions.

Beep-Jack™ Input Warning

The meter beeps as well as displays “InEr” to warn the user against possible damage to the meter due to improper connections to the μ A, mA, or A input jacks when another function, especially a voltage function, is selected.

Intelligent Auto-Power-Off (APO)

The Auto-Power-off (APO) mode turns the meter off automatically to extend battery life after approximately 32 minutes of no specified activities, where applicable:

- 1) Rotary switch or push button operations
- 2) Significant measuring readings of above 8.5% of ranges
- 3) Non-OL readings for Resistance, Continuity or Diode function
- 4) Non-zero readings for Hz function
- 5) Electric field signal present for EF function
- 6) Significant movement indication as in Phase Rotation functions

In other words, the meter will intelligently avoid entering the APO mode when it is under normal measurements. To wake up the meter from APO, press the **SELECT** button momentarily and release, or turn the rotary switch OFF and then back on. Always turn the rotary switch to the OFF position when the meter is not in use

5) MAINTENANCE

NOTE

To avoid electrical shock, disconnect the meter from any circuit, remove the test leads from the input jacks and turn OFF the meter before opening the case. Do not operate with open case. Install only the same type of fuse(s) or equivalent

Cleaning and Storage

Periodically wipe the case with a damp cloth and mild detergent; do not use abrasives or solvents. If the meter is not to be used for periods of longer than 60 days, remove the battery and store it separately

Trouble Shooting

If the instrument fails to operate, check battery, fuses, leads, etc., and replace as necessary. Double check operating procedure as described in this user's manual

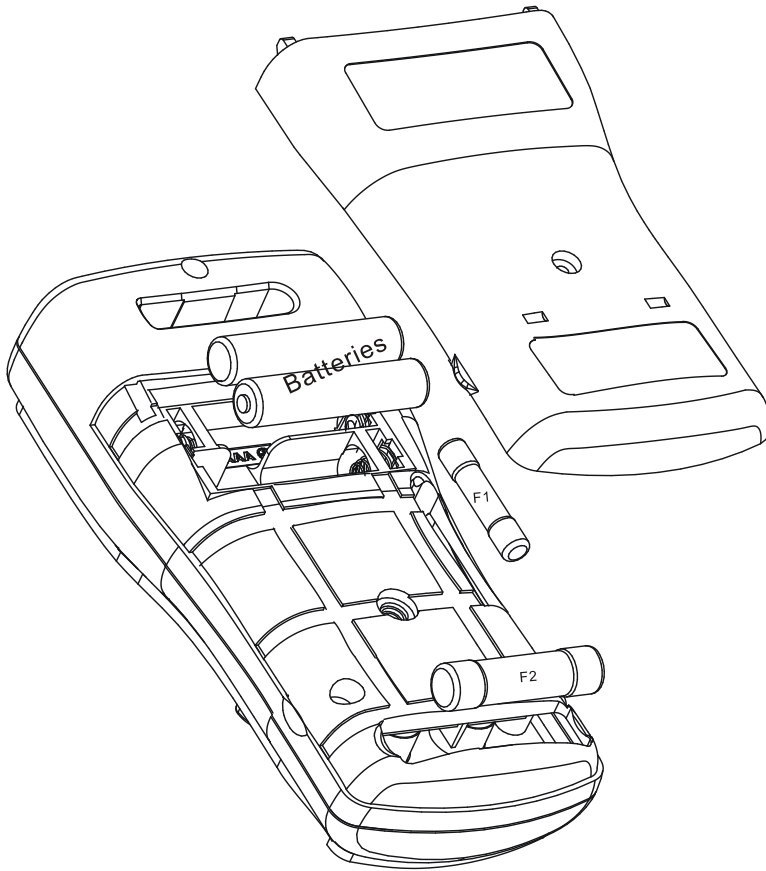

Battery use:

1.5V AAA Size battery x 2

Fuses use:

Fuse F1 for μ AmA current input:
0.4A/1000V DC/AC, IR 30kA F fuse or better; Dimension: 6 x 32 mm

Fuse F2 for A current input:
11A/1000V DC/AC, IR 20kA F fuse or better; Dimension: 10 x 38mm

Battery and Fuse replacement:

Loosen the screw from the access cover of the case bottom. Lift the access cover. Replace the batteries or fuse(s). Re-fasten the screw.

GENERAL SPECIFICATION

Display: 3-5/6 digits 6,000 counts

Update Rate: 5 per second nominal

Operating Temperature: -10°C to 45°C

Relative Humidity: Maximum relative humidity 80% for temperature up to 31°C decreasing linearly to 50% relative humidity at 45°C

Altitude: Operating below 2000m

Storage Temperature: -20°C ~ 60°C, < 80% R.H. (with battery removed)

Temperature Coefficient: Nominal $0.15 \times (\text{specified accuracy}) / ^\circ\text{C}$ @ -10°C ~ 18°C or 28°C ~ 45°C, or otherwise specified

Sensing: True RMS sensing

Ingress Protection: IP40

Pollution Degree: 2

Safety: Certified per IEC/UL/EN61010-1 Ed. 3.1, IEC/UL/EN61010-2-033 Ed. 2.0,

IEC/UL/EN61010-031 Ed. 2.0 and the corresponding CAN/CSA-C22.2 regulations to Measurement Categories:

CAT III 600V and CAT IV 300V AC & DC

Transient Protection: 6.0kV (1.2/50 μ s surge)

E.M.C. : Meets EN61326-1

In an RF field of 3V/m:

Temperature function is not specified

Ohm function:

Total Accuracy = Specified Accuracy + 15 digits

Other functions:

Total Accuracy = Specified Accuracy

Performance above 3V/m is not specified

Overload Protection:

μ A & mA: 0.4A/1000V DC/AC rms, IR 30kA, F fuse or better

A: 11A/1000V DC/AC rms, IR 20kA, F fuse or better

V & AutoV: 660Vdc / 1100Vac rms

mV, Ohm & others: 600Vdc/Vac rms

Low Battery: Below approx. 2.5V

Power Supply: 1.5V AAA Size battery X 2

Power Consumption (typical): 3.2mA

APO Consumption (typical): 10 μ A

APO Timing: Idle for 30 minutes

Dimension: 161*80*50mm L*W*H (With Holster)

Weight: Approx. 334 gm (With Holster)

Special Features: AutoV (LoZ) (Model 235 only); VFD; BeepLit™ Continuity; Auto-ranging MAX/MIN/AVG Record; Backlighted LCD; Auto-ranging Relative Zero mode; Display Hold; EF-Detection (NCV); BeepJack™ on μ AmA/A terminals

Accessories: Test lead pair; Batteries installed; User's manual; BKP60 banana plug type-K thermocouple (Model 235 only)

Optional Purchase Accessories: BKB32 banana plug to type-K socket plug adaptor (Model 235 only); BMH-01 magnetic hanger; BMP-25x soft carrying pouch

Electrical Specification

Accuracy is given as \pm (% of reading digits + number of digits) or otherwise specified @ 23°C \pm 5°C

ACV & ACA accuracies are specified from 1 % to 100 % of range or otherwise specified. Maximum Crest Factor <2:1 at full scale & <4:1 at half scale, and with

frequency components fall within the meter specified frequency bandwidth for non-sinusoidal waveforms

AC Voltage

RANGE	Accuracy
50Hz ~ 60Hz	
6.000V ¹⁾ , 60.00V, 600.0V	0.7% + 3d
45Hz ~ 440Hz	
6.000V ¹⁾ , 60.00V, 600.0V	2.0% + 3d

Input Impedance: 10M Ω , 54pF nominal

Overload protection: 1100Vrms for AC & 660V for DC

¹⁾<5d non-zero residue may appear when backlight is on, which will not affect the specified measuring range and accuracy

ACmV

RANGE	Accuracy
10Hz ~ 500Hz	
60.00mV ^{1) 2)} , 600.0mV ³⁾	1.0% + 3d
500Hz ~ 800Hz	
60.00mV ^{1) 2)} , 600.0mV ³⁾	2.0% + 3d

Overload protection: 600Vrms AC/DC

Input Impedance: 10M Ω , 54pF nominal

¹⁾<5d non-zero residue may appear when backlight is on, which will not affect the specified measuring range and accuracy

²⁾Signal peak absolute values, including DC bias, less than 130mV_{peak}

³⁾Signal peak absolute values, including DC bias, less than 1300mV_{peak}

VFD_ACV (with Low Pass Filter)

RANGE	Accuracy ¹⁾
10Hz ~ 100Hz (fundamental)	
600.0V	1.0% + 3d
100Hz ~ 400Hz (fundamental)	
600.0V	10% + 3d ²⁾

Overload protection: 1100Vrms for AC & 660V for DC

¹⁾Not specified for fundamental frequency > 400Hz

²⁾Accuracy linearly decreases from 1% + 3d @100Hz to 10% + 3d @400Hz

AutoV_ACV (Model 235 only)

RANGE	Accuracy ¹⁾
45Hz ~ 440Hz	
600.0V	2.0% + 3d

Overload protection: 1100Vrms for AC & 660V for DC

¹⁾Not specified at <1VAC

Threshold: > 1VAC nominal

Approximate input impedance (//164pF) for reference:

At direct input $\leq 50V_{ac}$ (typical) from quiescence:

>8M Ω @ < 5.6Vac

22k Ω @ 7Vac

12k Ω @ 8Vac

2.6k Ω @ 50Vac

At direct input $\gg 50V$ (typical) from quiescence:

Initial impedance is approximately 2.1k Ω . Impedance increases abruptly within a fraction of a second as display voltage (hard signal) is much higher than 50V (typical).

End-up impedances vs display voltages typically are:

12k Ω @100V

100k Ω @300V

240k Ω @600V

DC Voltage

RANGE	Accuracy
60.00mV ¹⁾ , 600.0mV ¹⁾ , 6.000V ²⁾	0.3% + 2d
60.00V ²⁾	0.4% + 2d
600.0V ²⁾	0.2% + 2d

Input Impedance: 10M Ω , 54pF nominal

¹⁾Overload protection: 600Vrms AC/DC

²⁾Overload protection: 1100Vrms for AC & 660V for DC

AutoV_DCV (Model 235 only)

RANGE	Accuracy ¹⁾
600.0V	2.0% + 3d

Overload protection: 1100Vrms for AC & 660V for DC

¹⁾Not specified at <1VDC

Threshold: > +1.0VDC or < -1.0VDC nominal

Approximate input impedance (//164pF) for reference:

At direct input $\leq 50\text{Vdc}$ (typical) from quiescence:

$>8\text{M}\Omega @ < 8\text{Vdc}$ (Protection clamping threshold)

$25\text{k}\Omega @ 9\text{Vdc}$

$13\text{k}\Omega @ 10\text{Vdc}$

$2.6\text{k}\Omega @ 50\text{Vdc}$

At direct input $\gg 50\text{V}$ (typical) from quiescence:

Initial impedance is approximately $2.1\text{k}\Omega$. Impedance increases abruptly within a fraction of a second as display voltage (hard signal) is much higher than 50V (typical).

End-up impedances vs display voltages typically are:

$12\text{k}\Omega @ 100\text{V}$

$100\text{k}\Omega @ 300\text{V}$

$240\text{k}\Omega @ 600\text{V}$

Ohm

RANGE ¹⁾	Accuracy
$600.0\Omega, 6.000\text{k}\Omega$	$0.3\% + 3\text{d}$
$60.00\text{k}\Omega, 600.0\text{k}\Omega$	$0.5\% + 3\text{d}$
$6.000\text{M}\Omega$ ²⁾ , $60.00\text{M}\Omega$ ³⁾	$0.9\% + 2\text{d}$ ⁴⁾

¹⁾Open Circuit Voltage: 1.6VDC typical

²⁾Constant Test Current: $0.2\mu\text{A}$ Typical

³⁾Constant Test Current: $0.02\mu\text{A}$ Typical

⁴⁾ $5\%+20\text{d} @ >30\text{M}\Omega$

BeepLit™ Continuity Tester

Continuity Threshold: Between 30Ω and 480Ω

Continuity ON Response Time: $<15\text{ms}$

Audible Indication: Beep sound

Visible Indication: LCD Backlight

Capacitance (Models 233 & 235 only)

RANGE	Accuracy
$20.00\text{nF}, 200.0\text{nF}$	$1.5\% + 8\text{d}$
$2000\text{nF}, 20.00\mu\text{F}, 200.0\mu\text{F}, 2000\mu\text{F}$	$1.5\% + 2\text{d}$
10.00mF	$4.5\% + 10\text{d}$

Accuracies with film capacitor or better

Diode Tester

RANGE	Accuracy
3.000V	0.9% + 2d

Test Current: 0.3mA typical

Open Circuit Voltage: < 3.2VDC typical

DC Current

RANGE	Accuracy	Burden Voltage
600.0μA, 6000μA	1.0% + 3d	0.1mV/μA
60.00mA, 600.0mA	0.7% + 3d	1.9mV/mA
6.000A, 10.00A ¹⁾		0.04V/A

¹⁾10A continuous, >10A to 20A for 30 seconds max with 5 minutes cool down interval

AC Current

RANGE	Accuracy	Burden Voltage
50Hz ~ 400Hz		
600.0μA, 6000μA	1.5% + 3d	0.1mV/μA
60.00mA, 600.0mA	1.0% + 3d	1.9mV/mA
6.000A ¹⁾ , 10.00A ²⁾		0.04V/A

¹⁾<5d non-zero residue may appear when backlight is on, which will not affect the specified measuring range and accuracy

²⁾10A continuous, >10A to 20A for 30 seconds max with 5 minutes cool down interval

Temperature (Model 235 only)

RANGE	Accuracy ^{1) 2)}
-40.0 °C ~ 99.9°C	1% + 1 °C
100 °C ~ 400°C	
-40.0 °F ~ 99.9 °F	1% + 2 °F
100 °F ~ 752 °F	

¹⁾Accuracies assume meter interior and the ambient have reached the same temperature (isothermal stage) for a correct junction voltage compensation. Allow enough settling time for a significant change of ambient temperature. It can take up to an hour for changes > 5°C.

²⁾Type-K thermocouple range & accuracy not included

Line Frequency (Models 233 & 235 only)

Function	Sensitivity (Sine RMS)	Range
60mV, 600mV	50mV	10Hz - 50kHz
6V	5V	10Hz - 50kHz
60V	10V	10Hz - 50kHz
600V	50V	10Hz - 1kHz
1000V	500V	10Hz - 1kHz
VFD 600V	50V	10Hz - 1kHz
VFD 1000V	500V	10Hz - 1kHz
600 μ A, 6000 μ A	500 μ A	10Hz - 5kHz
60mA, 600mA	50mA	10Hz - 5kHz
6A, 10A	8A	50Hz - 1kHz

Accuracy: 0.03% + 2d

Non-Contact EF-Detection

Bar-Graph Indication	EF-H (Hi Sensitivity)	EF-L (Lo Sensitivity)
	Typical Voltage (Tolerance)	
-	10V (3V ~ 19V)	40V (16V ~ 71V)
--	20V (10V ~ 38V)	80V (32V ~ 142V)
---	40V (21V ~ 79V)	160V (63V ~ 285V)
----	80V (40V ~ 156V)	300V (105V ~ 608V)
-----	160V (>80V)	500V (>300V)

Indication: Bar-graph segments & audible beep tones proportional to the field strength
 Detection Frequency: 50/60Hz

Detection Antenna: Top-left end of the meter

Probe-Contact EF-Detection: For more precise indication of live wires, such as distinguishing between live and ground connections, use direct contact testing with one single test-probe via the input terminal COM or V. The COM terminal (Black) has the best sensitivity.

LIMITED WARRANTY

BRYMEN warrants to the original product purchaser that each product it manufactures will be free from defects in material and workmanship under normal use and service within a period of one year from the date of purchase. BRYMEN's warranty does not apply to accessories, fuses, fusible resistors, spark gaps, batteries or any product which, in BRYMEN's opinion, has been misused, altered, neglected, or damaged by accident or abnormal conditions of operation or handling.

To obtain warranty service, contact your nearest BRYMEN authorized agent or send the product, with proof of purchase and description of the difficulty, postage and insurance prepaid, to BRYMEN TECHNOLOGY CORPORATION. BRYMEN assumes no risk for damage in transit. BRYMEN will, at its option, repair or replace the defective product free of charge. However, if BRYMEN determines that the failure was caused by misused, altered, neglected, or damaged by accident or abnormal conditions of operation or handling, you will be billed for the repair.

THIS WARRANTY IS EXCLUSIVE AND IS IN LIEU OF ALL OTHER WARRANTIES, EXPRESSED OR IMPLIED, INCLUDING BUT NOT LIMITED TO ANY IMPLIED WARRANTY OR MERCHANTABILITY OR FITNESS FOR A PARTICULAR PURPOSE OR USE. BRYMEN WILL NOT BE LIABLE FOR ANY SPECIAL, INDIRECT, INCIDENTAL OR CONSEQUENTIAL DAMAGES.



BRYMEN TECHNOLOGY CORPORATION

TEL:+886 2 2226 3396

FAX:+886 2 2225 0025

<http://www.brymen.com>



PRINTED ON RECYCLABLE PAPER, PLEASE RECYCLE

COPYRIGHT © MMXXIII BTC, ALL RIGHTS RESERVED

P/N: 7M1C-1501-C000

PRINTED IN TAIWAN